

3A Step-down DC/DC

Features

- 3A Output Current
- 0.15Ω Internal Power MOSFET Switch
- Stable with Low ESR Output Ceramic Capacitors
- Up to 95% Efficiency
- 30μA Shutdown Mode
- Fixed 380kHz Frequency
- Thermal Shutdown
- Cycle-by-Cycle Over Current Protection
- Wide 4.5V to 24V Operating Input Range
- Output Adjustable from 1.22V to 21.6V(G5753)
- Output Adjustable from 0.92V to 21.6V(G5753A)
- Available in SOP-8 (FD), DIP-8 & MSOP-10 (FD) Package

Applications

- PC Monitors
- DSL Modems
- Distributed Power Systems
- Pre-Regulator for Linear Regulators

General Description

The G5753/G5753A is a monolithic step-down switch mode regulator with a built in internal power MOSFET. It achieves 3A continuous output current over a wide input supply range with excellent load and line regulation.

Current mode operation provides fast transient response and eases loop stabilization.

Fault condition protection includes cycle-by-cycle current limiting, output short circuit protection and thermal shutdown. In shutdown mode the regulator draws 30μA of supply current. Programmable soft-start overwrites the internal soft-start for various requirement of output power up ramp and minimizes the inrush supply current at initial startup.

The G5753/G5753A requires a minimum number of readily available standard external components. It is available in a SOP-8 (FD), DIP-8 & MSOP-10 (FD) package.

Ordering Information

ORDER NUMBER	MARKING	TEMP. RANGE	PACKAGE (Green)
G5753F11U	G5753	-40°C to +85°C	SOP-8 (FD)
G5753AF11U	G5753A	-40°C to +85°C	SOP-8 (FD)
G5753Z31U	G5753	-40°C to +85°C	DIP-8
G5753AZ31U	G5753A	-40°C to +85°C	DIP-8
G5753F61U	G5753	-40°C to +85°C	MSOP-10 (FD)
G5753AF61U	G5753A	-40°C to +85°C	MSOP-10 (FD)

Note: F1: SOP-8 (FD) Z3: DIP-8 F6: MSOP-10 (FD)

1: Bonding Code

U : Tape & Reel

Pin Configuration

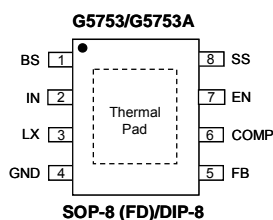

Note: Recommend connecting the Thermal Pad to the Ground for excellent power dissipation.

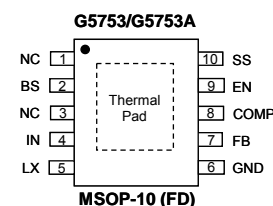

Note: Recommend connecting the Thermal Pad to the Ground for excellent power dissipation.

Typical Application Circuit

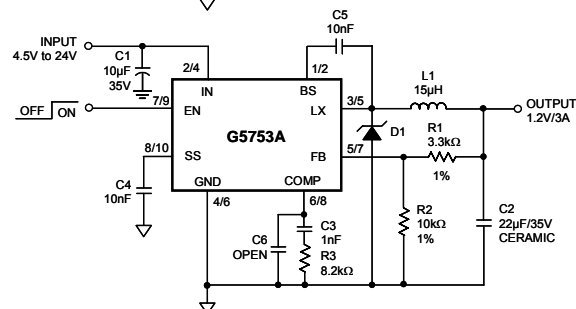
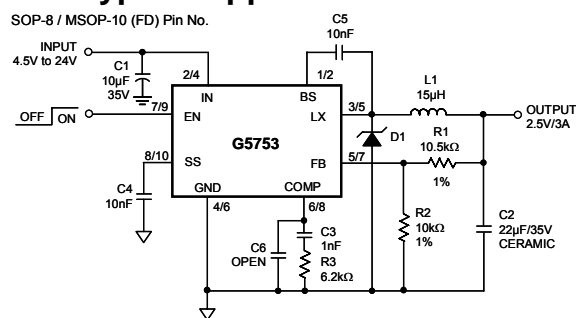

Note: Recommend choosing the small Vf of Diode to avoid LX to GND smaller then -0.7V.